

DC Axial Fans



FSY25X05L(M)(H) FSY25X12L(M)(H)

Features

Size: 25×25×10mm(1.0×1.0×0.40in)

Frame/Impeller: Reinforced Plastic UL94V-0

Bearings: Ball Bearing&Sleeve Bearing

Life Expectancy:50,000 Hours at 20°C-Ball

30,000 Hours at 20°C-Sleeve

Approvals: UL CUL TUV CE RoHS

Weight: 7g

  E318377 CE TUV AE50078959

• RoHS Compliant

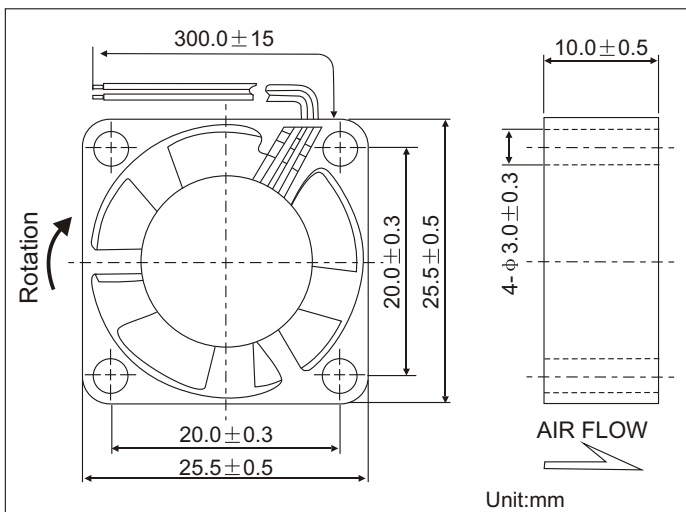

Air Flow vs Air Pressure

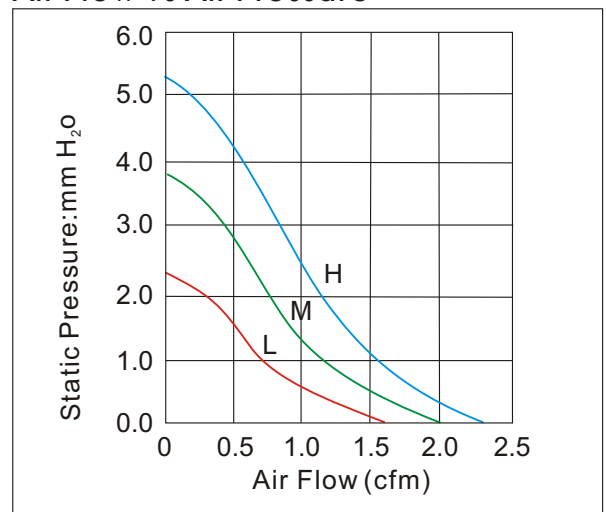

Performance

Model	Bearing System X			Rated Voltage (V)	Current (A)	Input Power (W)	Nominal Speed (R.P.M)	Air Flow (CFM)	Air Pressure (mm-H ₂ O)	Noise (dBA)
	S	B	D							
FSY25X05L	✓	✓	✓	5	0.12	0.60	8000	1.57	2.17	18
FSY25X05M	✓	✓	✓	5	0.18	0.90	10000	2.00	3.88	21
FSY25X05H	✓	✓	✓	5	0.22	1.10	12000	2.36	5.25	23
FSY25X12L	✓	✓	✓	12	0.08	0.96	8000	1.57	2.17	18
FSY25X12M	✓	✓	✓	12	0.10	1.20	10000	2.00	3.88	21
FSY25X12H	✓	✓	✓	12	0.12	1.44	12000	2.36	5.25	23