



FSY65X05L(M)(H) FSY65X12L(M)(H) FSY65X24L(M)(H)

Features

Size: 60×60×15mm(2.36×2.36×0.59in)

Frame/Impeller: Reinforced Plastic UL94V-0

Bearings: Ball Bearing&Sleeve Bearing

Life Expectancy:50,000 Hours at 20°C-Ball

30,000 Hours at 20°C-Sleeve

Approvals: UL CUL TUV CE RoHS

Weight: 30g

E318377 CE TUV AE50078978

▪ RoHS Compliant

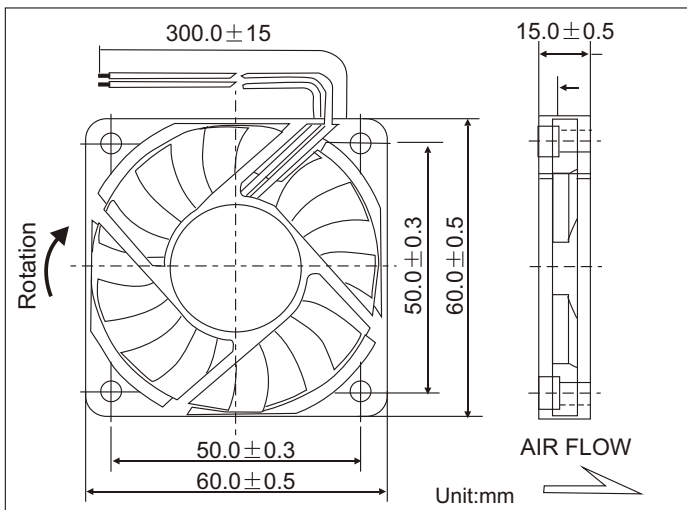

Air Flow vs Air Pressure

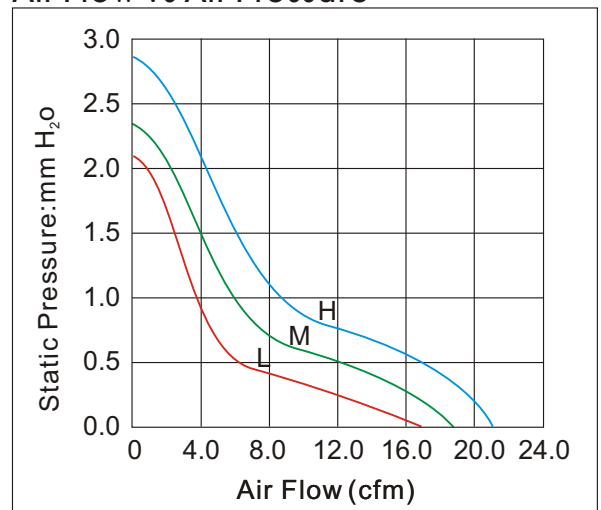

Performance

Model	Bearing System X			Rated Voltage (V)	Current (A)	Input Power (W)	Nominal Speed (R.P.M)	Air Flow (CFM)	Air Pressure (mm-H ₂ O)	Noise (dBA)
	S	B	D							
FSY65X05L	✓	✓	✓	5	0.20	1.00	3500	16.25	2.15	27
FSY65X05M	✓	✓	✓	5	0.25	1.25	4000	18.10	2.31	32
FSY65X05H	✓	✓	✓	5	0.30	1.50	4500	20.52	2.75	35
FSY65X12L	✓	✓	✓	12	0.12	1.44	3500	16.25	2.15	27
FSY65X12M	✓	✓	✓	12	0.15	1.80	4000	18.10	2.31	32
FSY65X12H	✓	✓	✓	12	0.20	2.40	4500	20.52	2.75	35
FSY65X24L	✓	✓	✓	24	0.08	1.92	3500	16.25	2.15	27
FSY65X24M	✓	✓	✓	24	0.10	2.40	4000	18.10	2.31	32
FSY65X24H	✓	✓	✓	24	0.15	3.60	4500	20.52	2.75	35