

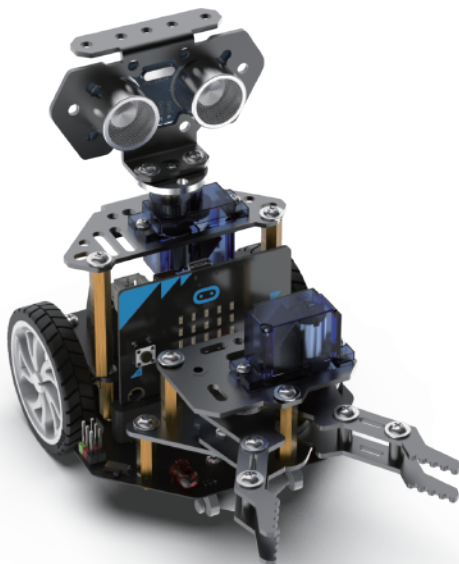

**DFROBOT**  
DRIVE THE FUTURE

## Maqueen Mechanic



## Installation Manual



## Part List



● Loader Servo Panel



● Loader Bucket



● Pan-tilt-zoom  
Mount Plate

×2



● Trolley Plate



● Ultrasonic Mount  
Holder



● Arm Servo Base



● Arm Baseplate



● Arm Linkage

×3



● Arm Plate



● Servo Arm Linkage



● Forklift Plate



● Gripper Upper Arm

×2

# Part List



● Gripper Driven Forearm



● Gripper Servo Forearm



● Gripper Panel



● Gripper Triangular Mount Plate



● M3\*35mm Copper Bolt



● M3\*25mm Copper Bolt



● M3\*15mm Copper Bolt



● M3\*18mm Copper Bolt



● Servo



● M2.5\*5mm Screw



● M3\*5mm Screw





# Assemble and Install

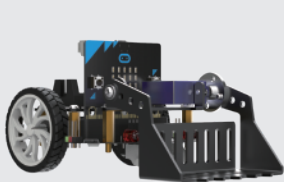

**Loader**

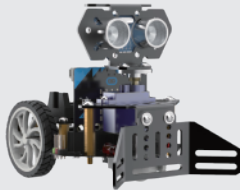

**Bulldozer**

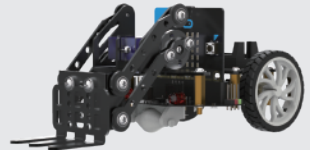

**Forklift**

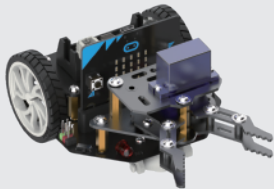

**Mechanical Beetle**

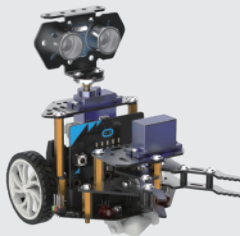

**Pan-tilt-zoom  
Mechanical Beetle**

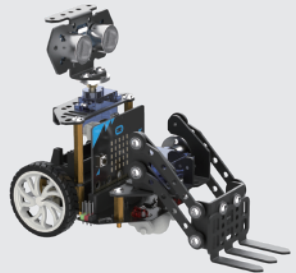

**Pan-tilt-zoom Forklift**



**Pan-tilt-zoom Loader**



**Loading Truck**

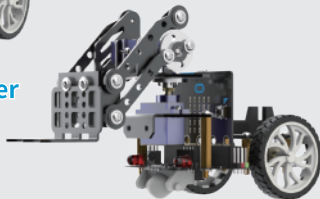

**Rotating Forklift**

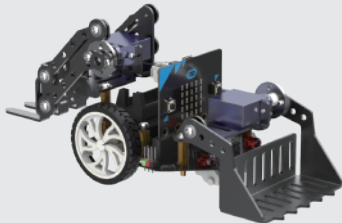

**Multi-Purpose  
Engineering Vehicle(MPEV)**

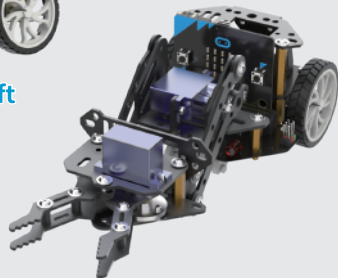

**Liftable  
Mechanical Beetle**



# Install Loader

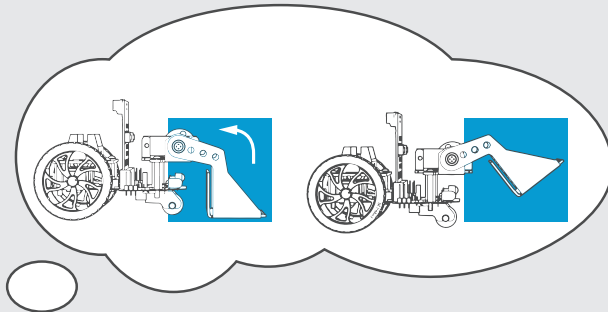

# Install Loader

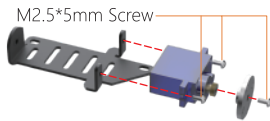

● Step1

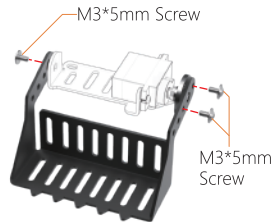

● Step2

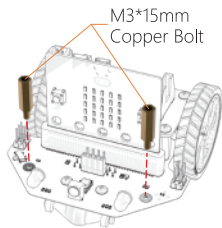

● Step3

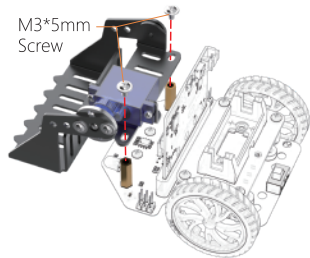

● Step4



# Install Bulldozer

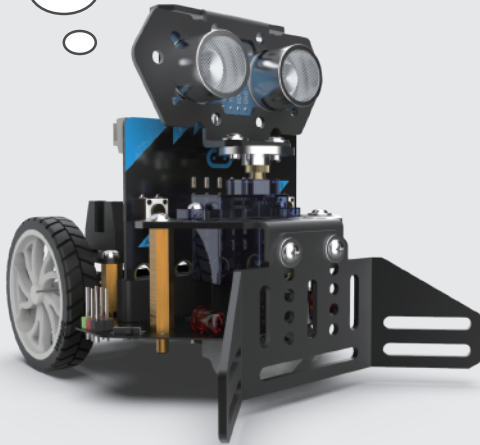
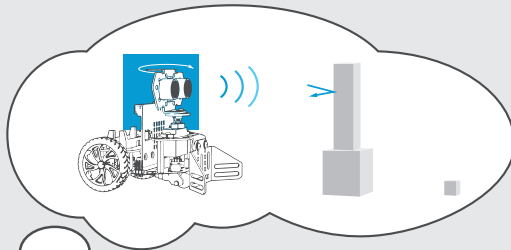



# Install Bulldozer



● Step1

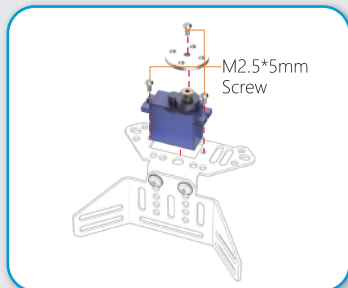

● Step2

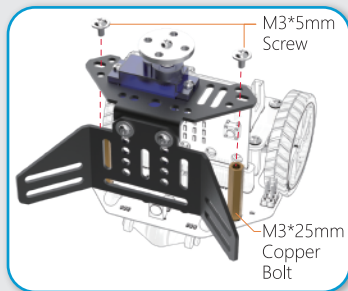

● Step3

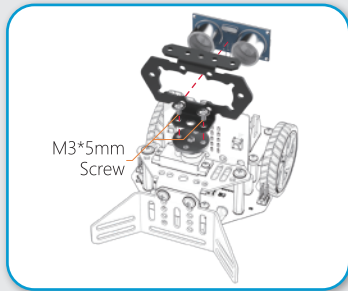

● Step4



# Install Forklift

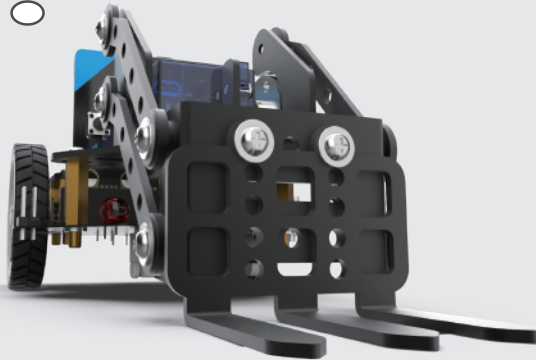
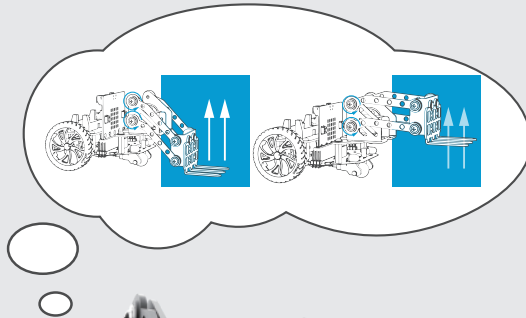

# Install Forklift

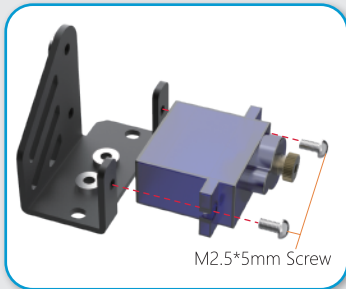

● Step1

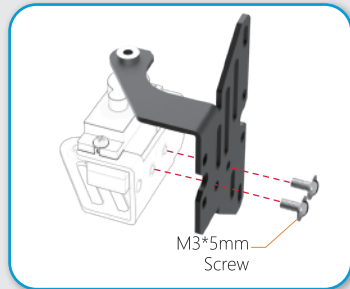

● Step2

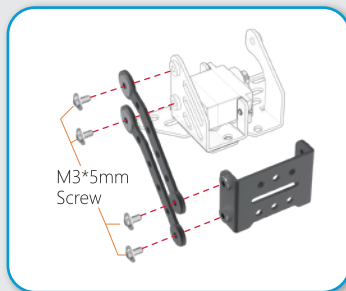

● Step3

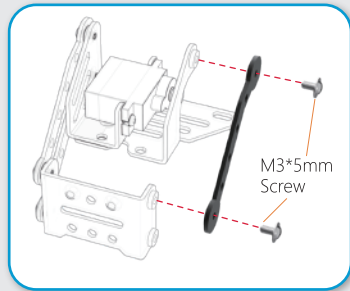

● Step4



# Install Forklift

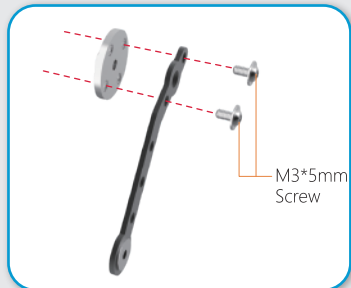

● Step5

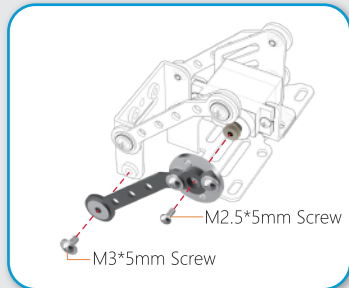

● Step6

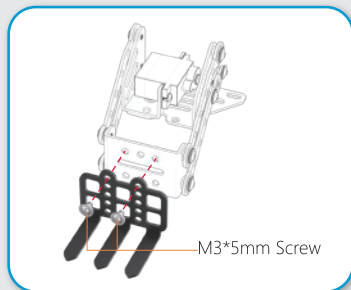

● Step7

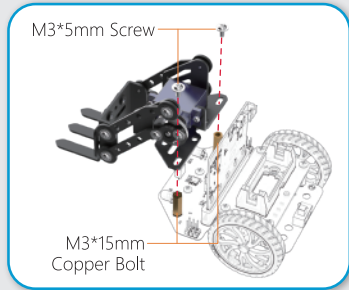

● Step8

# Install Mechanical Beetle

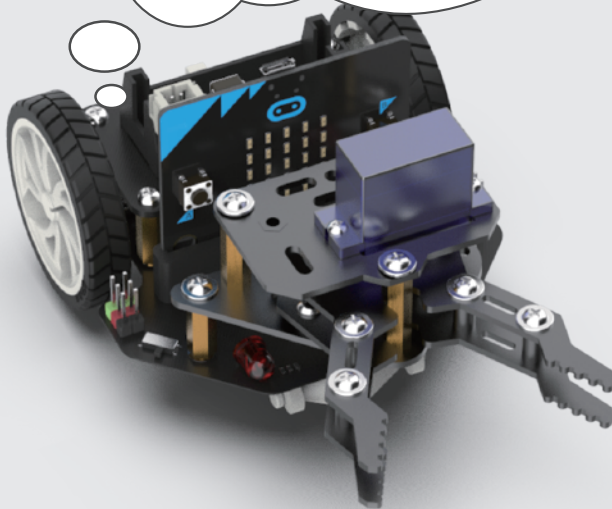
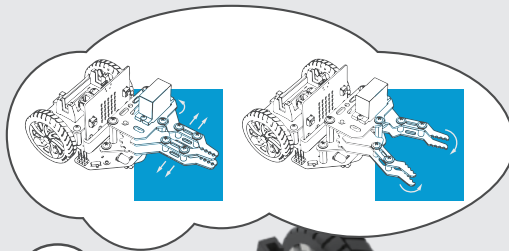



# Install Mechanical Beetle

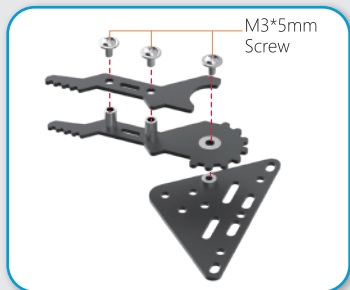

● Step1

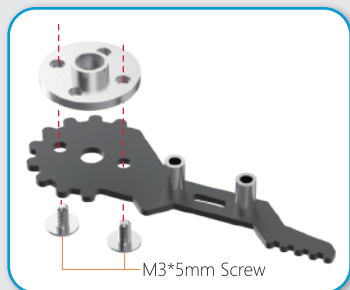

● Step2

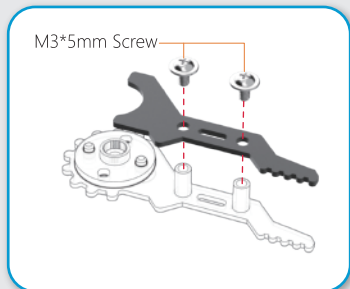

● Step3

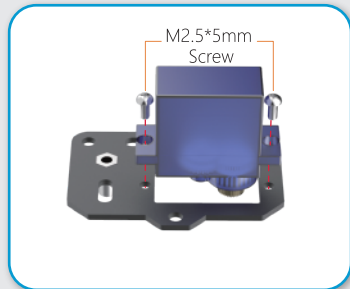

● Step4

# Install Mechanical Beetle

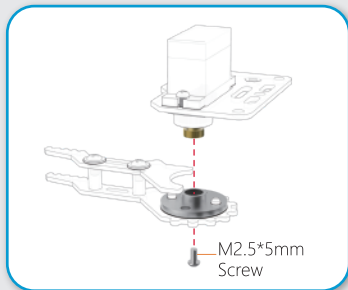

● Step5

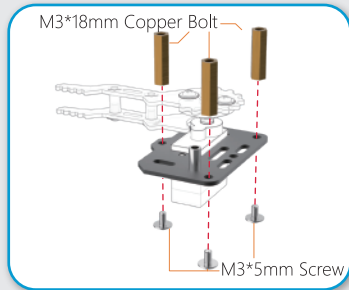

● Step6

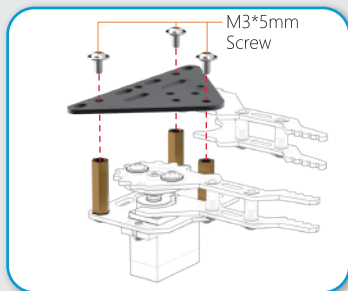

● Step7

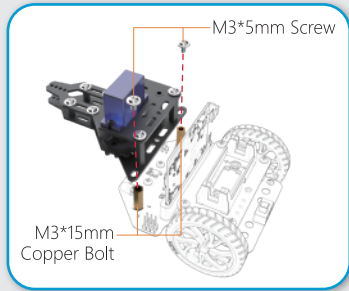

● Step8



# Install Pan-tilt-zoom Mechanical Beetle

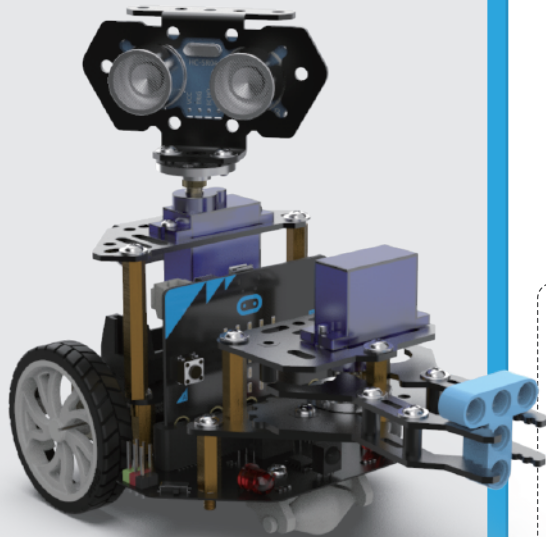

## Diagram

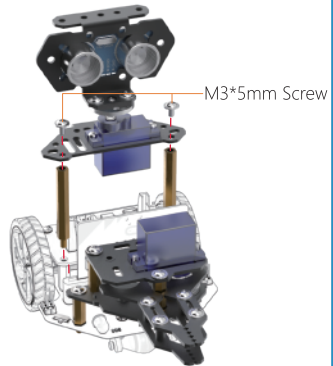

### Side View

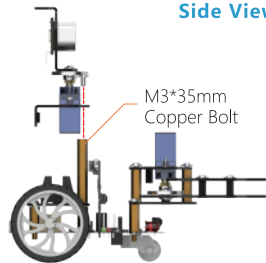



# Install Pan-tilt-zoom Forklift

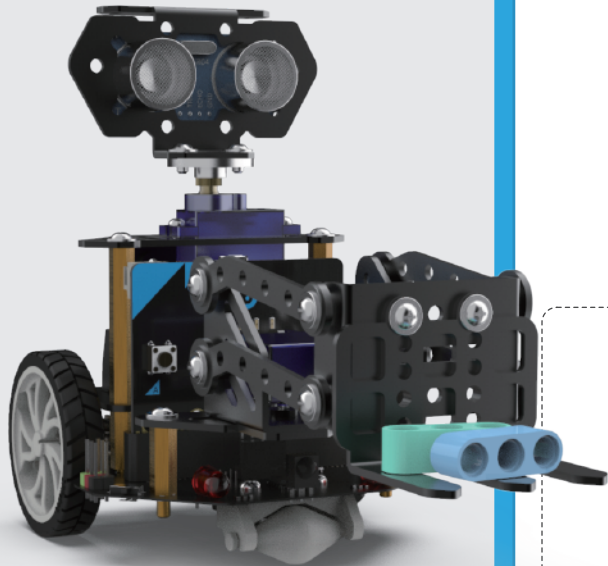

## Diagram

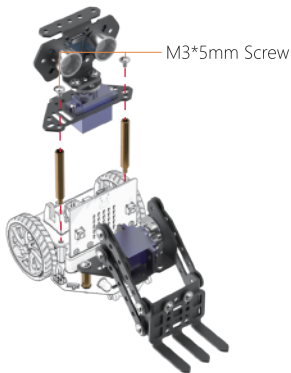

## Side View

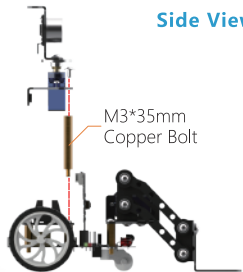



# Install Pan-tilt-zoom Loader

## Diagram

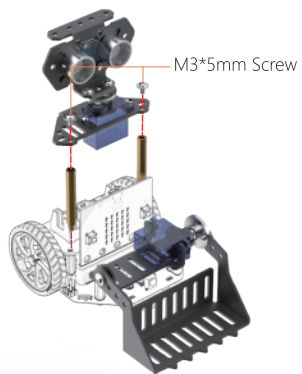

### Side View

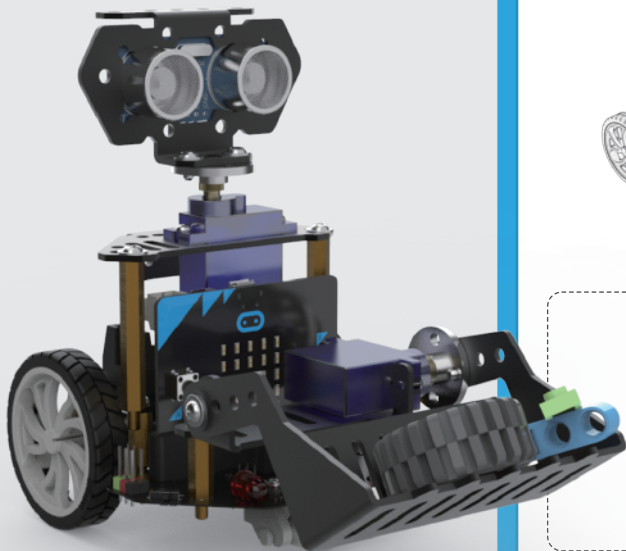
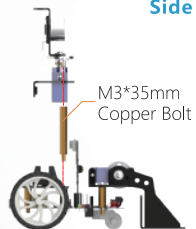

# Install Rotating Forklift



## Diagram

M3\*5mm Screw

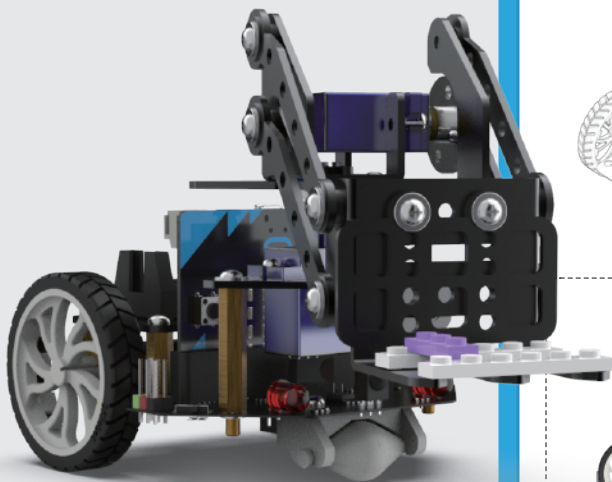
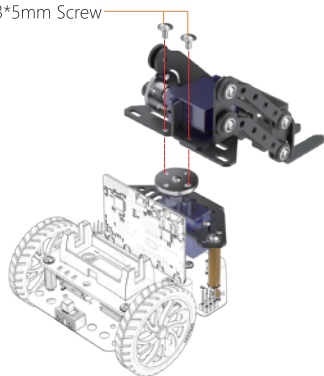

Side View

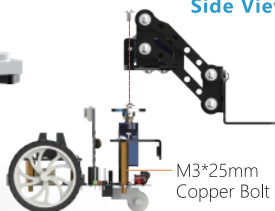

M3\*25mm  
Copper Bolt



# Install Loading Truck

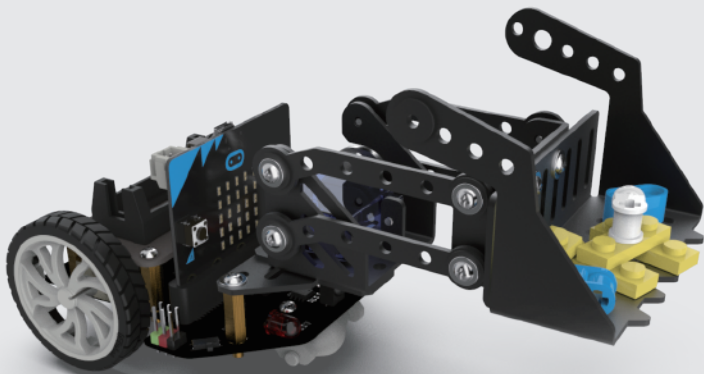

## Diagram

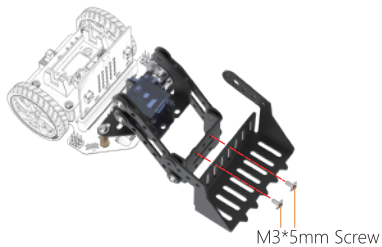

### Side View

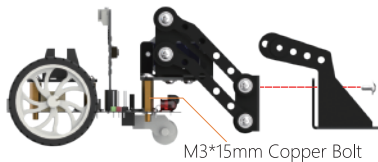

# Install MPEV

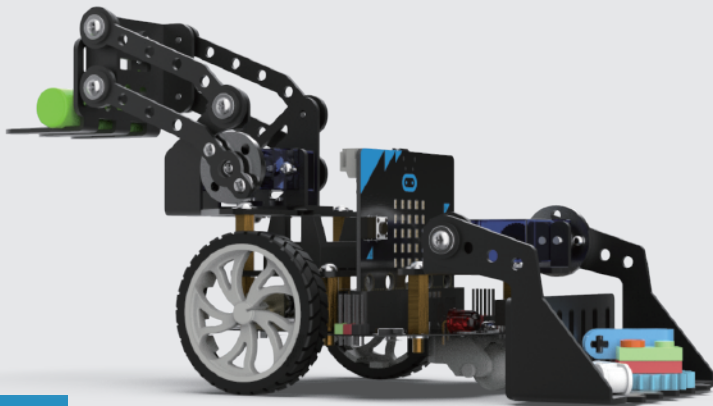

## Diagram

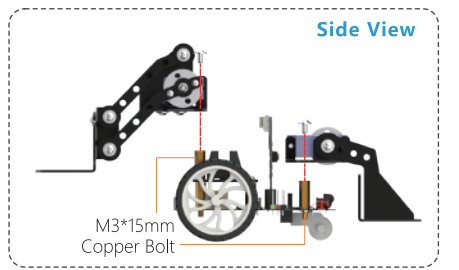
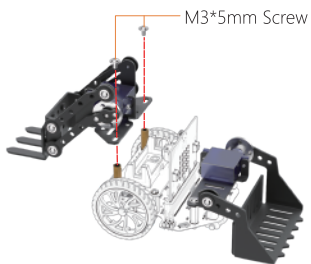



## Install Liftable Mechanical Beetle

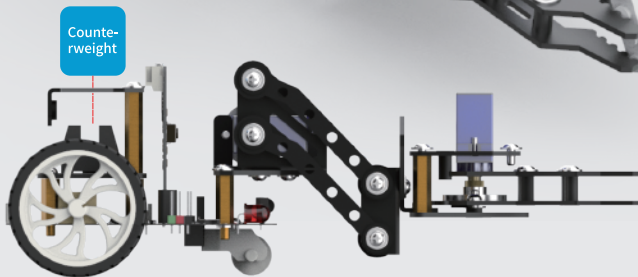
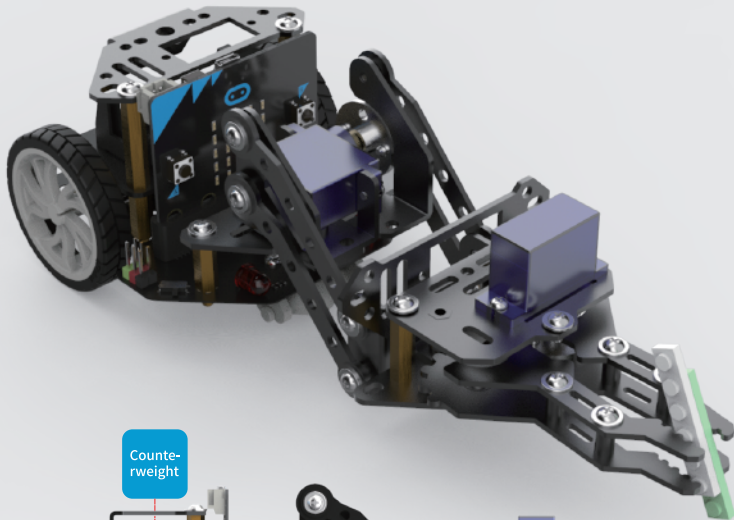

# Install Liftable Mechanical Beetle



## Diagram

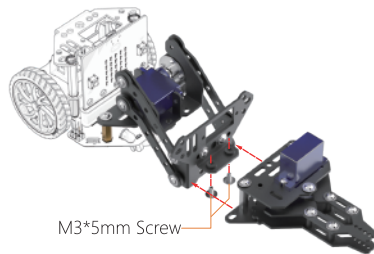
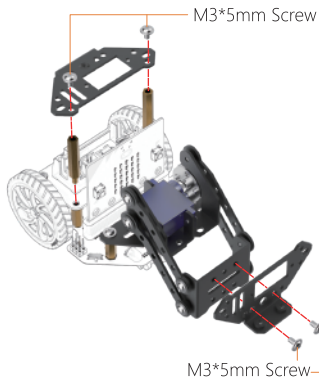

### Side View

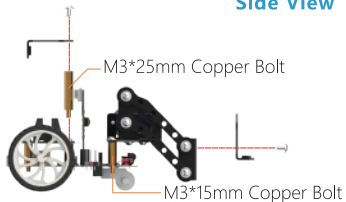

### Side View

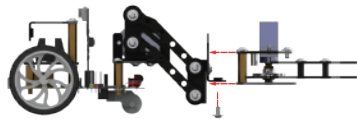

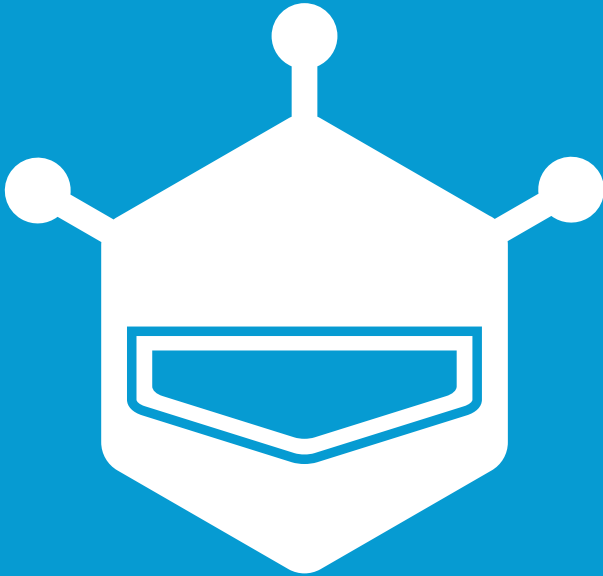

Welcome to  
**[www.dfrobot.com](http://www.dfrobot.com)**  
for more details